

Air Scrubber+ Ozone

by activTek®

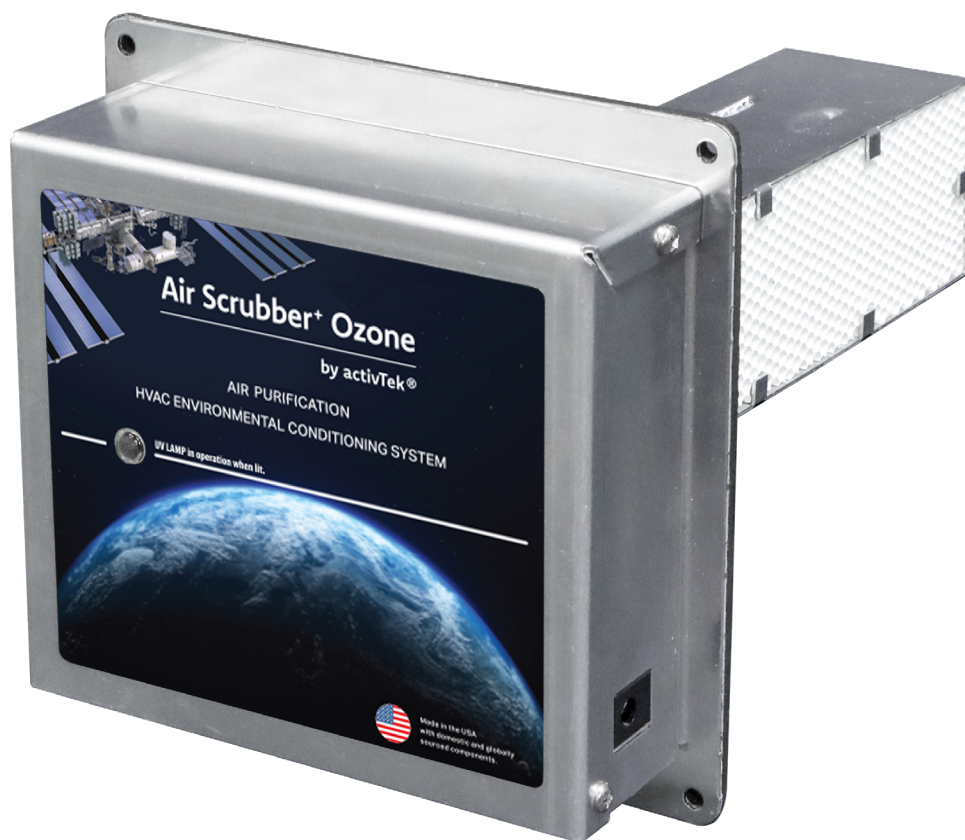

Duct Mounted Air Purification System

Read manual carefully for proper use and optimal operation.

General Information

Product Overview

Congratulations on your purchase of the Air Scrubber+ Ozone by activTek®! The unit is easily mounted into the supply side of air conditioning and heating system air ducts by an electrician or HVAC professional, where it will provide around-the-clock air purification while the HVAC system is running. Please read and follow all safety warnings and instructions outlined in this manual before installing or performing maintenance.

Contents

Product Overview	2
Specifications	2
Storage and Disposal	2
Important Safety Instructions	3
Product Features	4
Installation Hardware (Supplied)	4
Recommended Installation Tools	4
Directions for Use and Installation Requirements	5
Installing the Unit	6
Wiring the Unit	7
Maintenance/ PCO-A Cell Indicator	8
Replacing the PCO-A Cell Assembly	8
Replacing the Ballast	10
Troubleshooting	11
Replacement Parts	12
Warranty Information	13
FCC Declaration & Responsible Party	14

Specifications

Air Scrubber+ Ozone by activTek _____

- Sales Number: 9960051
- Model Number: A1013AA

DOES NOT meet California requirements and cannot be shipped to California or Canada

Technology _____

- PCO-A (Photocatalytic Oxidation-Advanced) Technology
- (1) 9" Cell Assembly
- Ozone (O₃)

Electrical _____

- Input Voltage: 24 Volts AC; 50/60Hz; 1.0 Amp
- Power: 17 Watts

Mechanical _____

- Distribution via Air Handler
- Safety switch installed

Weight & Dimensions _____

- 3 lbs
- 6.5" H x 6.5" W x 2.2" D

Cell Dimensions _____

- 2.3" H x 2.3" W x 9.0" D

Operating Temperature _____

- 34°F – 200°F

Coverage _____

- Up to 2,000 sq. ft., with uniform air diffusion; not to exceed 3,000 sq. ft.¹

Warranty _____

- Limited Lifetime Warranty on unit; 2 year warranty on PCO-A Cell Assembly
- Terms and conditions may apply

We reserve the right to change or modify any specification without notice.

¹ Recommended ceiling height to not exceed 10 feet. Solutions should be customized based upon a variety of factors including HVAC system capabilities and settings, air flows taking into account walls, air pressure, and doors, ambient air temperatures and humidities, variable occupant density, known VOC concentrations, and other layers of protection.

Fill In and Save

Record information regarding your new Air Scrubber+ Ozone by activTek here. Retain for future reference.

Model No. _____ Serial No. _____ Date of Purchase _____

Name: _____ Phone No. _____

Address: _____

Sales Representative: _____

Storage and Disposal

Do not dispose of this product as household waste. Electrical waste and electronic products should be appropriately recycled as required by practices established by your local authority.



If you have any questions regarding the use of this product, please contact your Sales Representative or Customer Service at 866.736.0503 or email support@activTek.net.

Important Safety Instructions



WARNING

- UV Light in operation; disconnect unit from power supply before servicing; failure to follow warnings may result in severe eye damage and electrical shock
- To prevent damage to the unit, operating environment temperature must never exceed 200oF
- DO NOT use this unit with an extension cord
- This unit is equipped with a universal ballast that operates at nominal voltages 24 VAC
- To Reduce the Risk of Electric Shock – DO NOT use in wet or damp locations; this equipment emits UV-C radiation; DO NOT locate equipment in any location allowing direct line-of-sight to vents, returns, or other duct openings
- DO NOT connect this unit to any voltage source above 32 volts; doing so will cause damage to the unit



CAUTION

- Wiring and installation of this unit must be done by a licensed HVAC contractor or electrician; failure to do so will void warranty of the product
- When the unit is installed in a roof mounted HVAC system, the unit must be protected from the elements
- The Air Scrubber+ Ozone by activTek® requires power 24/7; DO NOT install where power to the unit will be cycled on and off



Location for Protective Earth Line.

Read this manual in its entirety before using your Air Scrubber+ Ozone by activTek.

Keep out of the reach of children.

- Live voltage may be present
- **Power Connection Requirements:** This device is designed to operate using a 24 VAC, 40Va transformer; transformers supplied with a straight cooling or HVAC system may be used to power the device but must be verified it's capable of handling the additional device load before installation; if the system transformer is not capable of handing the extra load, a separate 24 VAC, 40Va transformer **MUST** be used; **DO NOT** connect the device to any power source with a voltage less than 22 VAC and a maximum of 32 VAC; doing so will cause damage to the device
- Disconnect power at the breaker or fuse panel before servicing unit; always follow OSHA electrical lockout procedures to prevent accidental exposure to electrical energy
- If installed near a furnace heat exchanger or where emergency heat coils could raise the temperature inside the plenum, cycle the AC unit through the heating cycles assuring that the temperature never exceeds 200°F. The PCO-A Cell Assembly must not exceed 200°F
- If the unit is hard wired, be sure the power to the unit is off; always follow OSHA electrical lockout safety requirements to prevent accidental release of energy during service or maintenance activities
- Never attempt to check operation of the PCO-A Cell Assembly by direct observation; severe eye damage can result; check the indicator light on the front face of the unit, if light is on the Cell is operating

Save these instructions.

Product Features

It is important to be familiar with the parts of the Air Scrubber+ Ozone by activTek. If any parts are missing, please contact your Sales Representative or Customer Service at 866.736.0503 or email support@activtek.net.

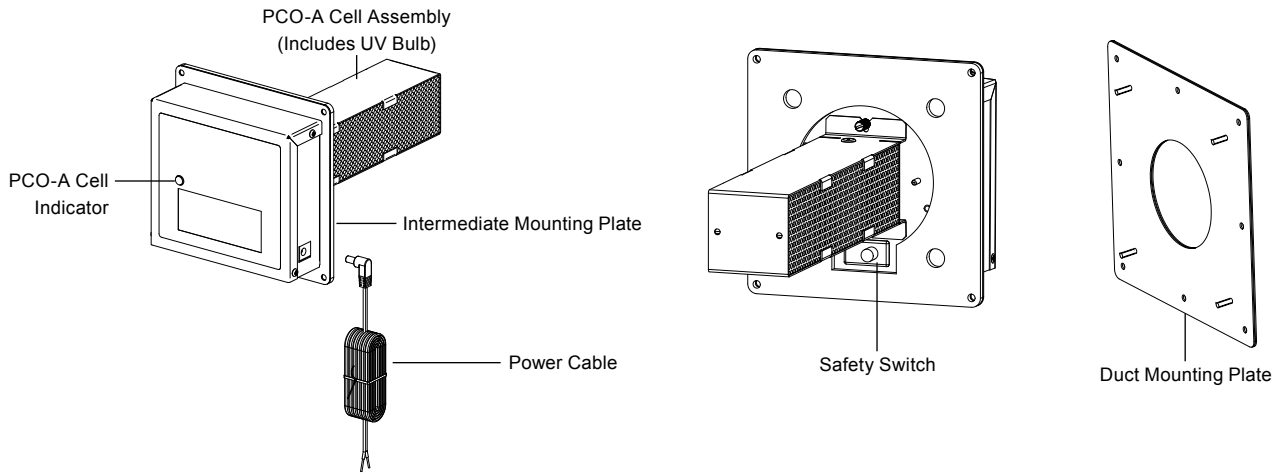

Installation Hardware (supplied)



(8) #8 — .75
1/4" Self-tapping screws

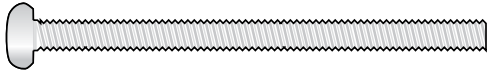

(4) #6 — 32 x 2" Threaded bolts



(2) Black thumb nuts
(4) Off-white thumb nuts

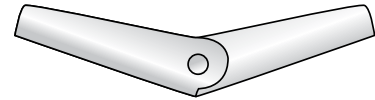

(4) #6 — 32 Toggle
bolt wall anchors

Recommended Installation Tools



CAUTION

When the unit is installed in a roof mounted HVAC system, the unit must be protected from elements.

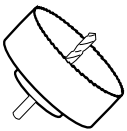

3 1/2" Hole Saw
(for wood or metal)

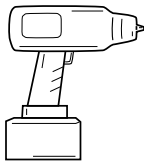

Drill / Power Driver



Phillips Screwdriver



3/8" Drill Bit
(if installing into fiberglass
ducting with toggle bolts)

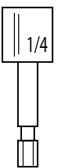

1/4" Nut Driver Bit

YOU MAY ALSO NEED:

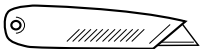

Utility Knife

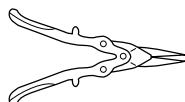

Tin Snips
(for metal ductwork)

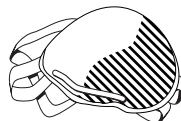

Dust Mask

Directions for Use and Installation Requirements



WARNING

- **Power Connection Requirements:** This device is designed to operate using a 24 VAC, 40Va transformer; transformers supplied with a straight cooling or HVAC system may be used to power the device but must be verified it's capable of handling the additional device load before installation; if the system transformer is not capable of handling the extra load, a separate 24 VAC, 40Va transformer **MUST** be used; **DO NOT** connect the device to any power source with a voltage less than 22 VAC and a maximum of 32 VAC; doing so will cause damage to the device
- If installed near a furnace heat exchanger or where emergency heat coils could raise the temperature inside the plenum, cycle the AC unit through the heating cycles assuring that the temperature never exceeds 200 °F; the PCO-A Cell Assembly must not exceed 200°F



CAUTION

- This unit must be installed by a licensed HVAC contractor or electrician; failure to do so will void warranty of the product
- When the unit is installed in a roof mounted HVAC system, the unit must be protected from the elements
- The Air Scrubber+ Ozone by activTek® requires power 24/7; Do not install where power to the unit will be cycled on and off

1. The Air Scrubber+ Ozone by activTek® unit should be installed after the air handler in the HVAC system.
2. The ductwork around the installation area should be clean and dry to ensure proper adhesion of the gasket materials and any tape used.
3. When installing near a furnace heat exchanger or heating coils, run the heating system through the heating cycles to ensure the temperature of the Air Scrubber+ Ozone by activTek unit does not exceed 200°F.
4. An approximate 3.5" opening will need to be cut into the existing ductwork to install the unit properly.

NOTE: The Air Scrubber+ Ozone by activTek® requires power 24/7. Do not install where power to the unit will be cycled on and off.

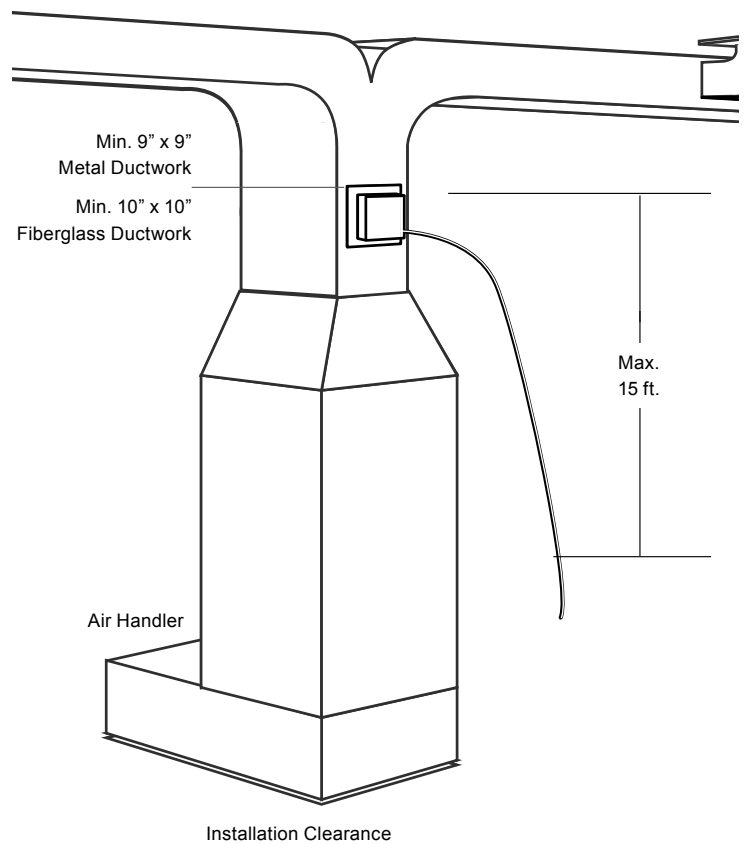

If you have any questions regarding installation requirements, please contact your Sales Representative or Customer Service at 866.736.0503 or email support@activTek.net.

Installing the Unit



To Reduce the Risk of Electric Shock – DO NOT use in wet or damp locations. This equipment emits UV-C radiation. DO NOT locate equipment in any location allowing direct line-of-sight to vents, returns, or other duct openings. Disconnect from supply before servicing or replacing.



- Hard wiring unit into HVAC system must be done by a licensed HVAC installer or electrical contractor only
- When the unit is installed in a roof mounted HVAC system, the unit must be protected from elements
- The Air Scrubber+ Ozone by activTek® requires power 24/7; DO NOT install where power to the unit will be cycled on and off
- This unit emits ozone; install unit to properly cover the total ventilated indoor area

Find the optimal position downstream from the air handler. Ensure location in duct has enough room for the Mounting Plate. It is recommended for maximum effectiveness that the unit be placed as close to the air handler as possible.

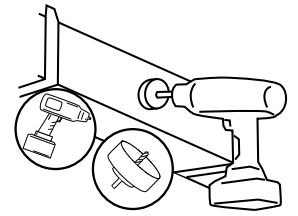
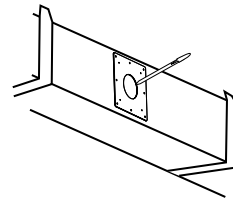
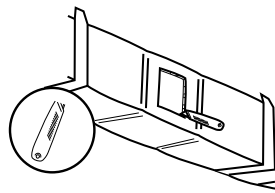
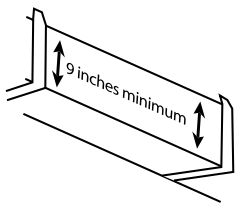

1. Locate suitable area of duct for installation.
2. Cut away insulation to expose metal duct (if needed).
3. Mark location for 3.5" opening using the Duct Mounting Plate.
4. Cut hole in Duct Mounting Plate using 3.5" hole saw.

ALTERNATE CUTTING METHOD:

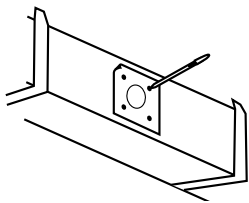

- a. Using the Duct Mounting Plate, mark four cutting method holes on duct.

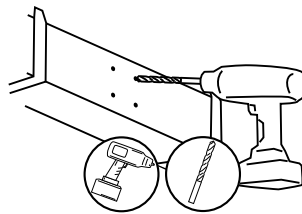

- b. Drill four holes where marked.

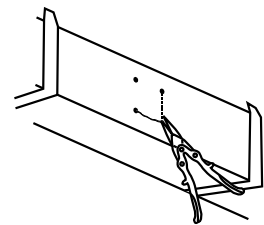

- c. Cut between holes using tin snips.

Installing the Unit (continued)

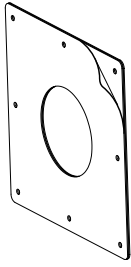

5. Remove backing from Duct Mounting Plate adhesive gasket.

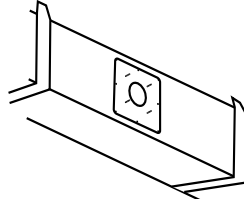

6. Center openings and press Duct Mounting Plate onto duct. The adhesive gasket will hold the mounting plate in place.

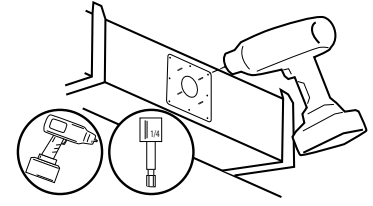

7. Secure the Duct Mounting Plate using eight (8) #8 self-tapping screws.

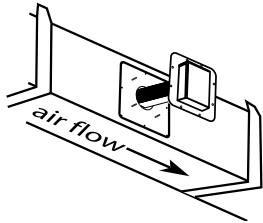

8. Insert unit into opening. Be sure the air will pass through the PCO-A Cell Assembly Honeycomb Matrix.

Vertical Mount Option

If installing in a vertical up flow duct, it may be necessary to rotate the PCO-A Cell Assembly 90 (degrees) to keep the Honeycomb Matrix in the airflow. Use (2) black thumb nuts to secure the PCO-A Cell Assembly onto the unit. (See step #8)

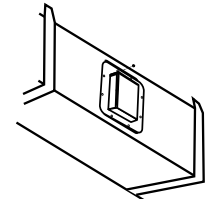

9. Secure the unit to the Duct Mounting Plate with four (4) off-white thumb nuts.

NOTE: Connect the unit to the load side of the transformer.

Wiring The Unit



WARNING

- Disconnect power at the breaker or fuse panel before servicing unit
- Always follow OSHA electrical lockout procedures to prevent accidental exposure to electrical energy

CAUTION

- Hard wiring unit into HVAC system should be done by a licensed HVAC installer or qualified electrical contractor only
- The Air Scrubber+ Ozone by activTek requires power 24/7; DO NOT install where power to the unit will be cycled on and off

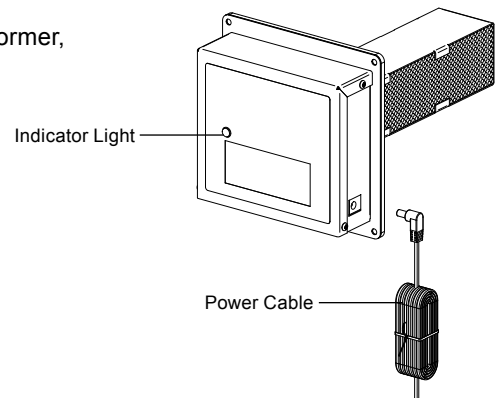
1. The Power Cable is separate from the unit. Attach the Power Cable to the transformer, then plug the Power Cable onto the side of the unit.
2. Check indicator light for proper operation.
3. Verify unit operation; Indicator light will be illuminated.



Maintenance / PCO-A Cell Indicator



CAUTION

For optimal performance and to maintain the Limited Lifetime Warranty, it is required to replace the PCO-A Cell Assembly once every two (2) years, even if the PCO-A Cell appears to be operating normally.

Your Air Scrubber+ Ozone by activTek unit requires no periodic maintenance beyond normal replacement of the PCO-A Cell Assembly every two (2) years. The PCO-A Cell has an effective life of 18,000 continuous hours.

The PCO-A Cell Indicator on the face of the unit will glow when the PCO-A Cell is in use. If the indicator does not glow and the unit has power, the PCO-A Cell Assembly should be replaced.



PCO-A Cell Indicator

Replacing the PCO-A Cell Assembly



WARNING

- **UV Light in operation; disconnect unit from Power Cable before servicing; failure to follow warnings may result in severe eye damage**
- **Disconnect power at the breaker or fuse panel before servicing unit**
- **Always follow OSHA electrical lockout procedures to prevent accidental exposure to electrical energy**



CAUTION

- **For optimal performance and to maintain the Limited Lifetime Warranty, it is required to replace the PCO-A Cell Assembly once every two (2) years, even if the PCO-A Cell appears to be operating normally**
- **Use genuine activTek replacement parts only; parts from anyone other than an authorized activTek Representative may damage your unit and void your warranty**

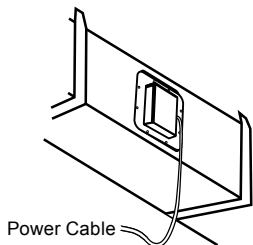

1. Disconnect (unplug) Power Cable from unit.

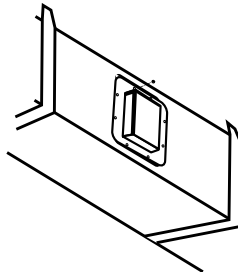

2. Remove the four (4) thumb nuts.

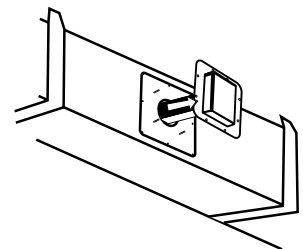

3. Remove the unit from the Duct Mounting Plate.

Replacing the PCO-A Cell Assembly (continued)

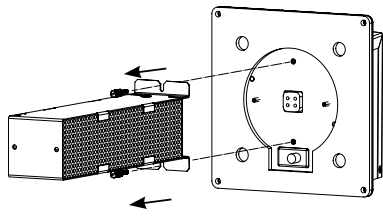

4. Remove the two (2) thumb screws holding the PCO-A Cell Assembly.

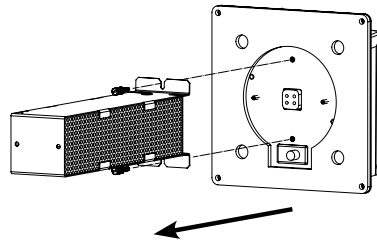

5. Remove the used PCO-A Cell Assembly from the base of the unit and dispose of the Cell Assembly properly.

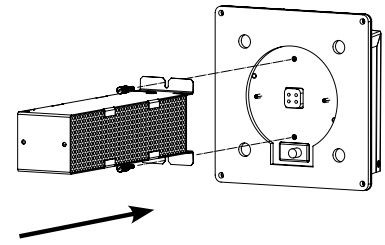

6. Plug the new PCO-A Cell Assembly into the base of the unit. Be sure Air Flow is passing through the Honeycomb Cell.

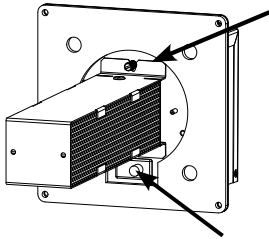

7. Secure with two (2) thumb screws.

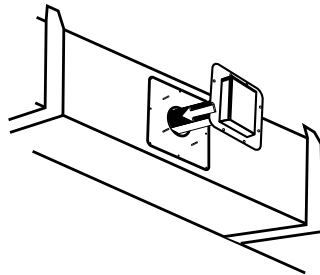

8. Insert the Air Scrubber+ Ozone by activTek® into the Duct Mounting Plate.

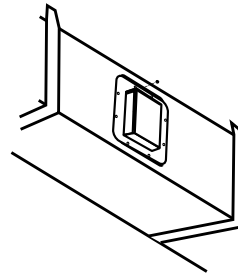

9. Secure unit with four (4) thumb nuts.

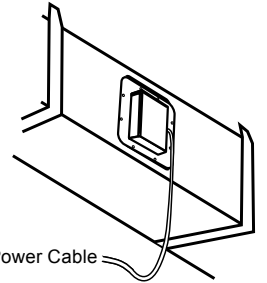

10. Reconnect Power Cable.



Visit lamprecycle.org for proper cell disposal regulations

Replacing the Ballast



- UV Light in operation; disconnect unit from Power Cable before servicing; failure to follow warnings may result in severe eye damage
- Disconnect power at the breaker or fuse panel before servicing unit
- Always follow OSHA electrical lockout safety requirements to prevent accidental exposure to electrical energy



Use genuine activTek replacement parts only; Parts from anyone other than an authorized activTek Representative may damage your unit and void your warranty.

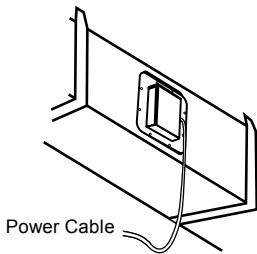

1. Disconnect (unplug) Power Cable from unit.



2. Open the Ballast housing by removing the four (4) screws then removing the Cover.

NOTE: The screws are under the face plate label indicated by the small "X".

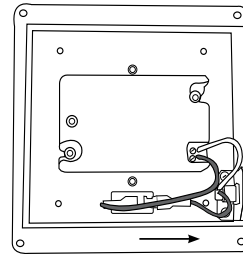

3. Disconnect all Ballast wiring by pressing down on connector tabs and pulling wire straight out.

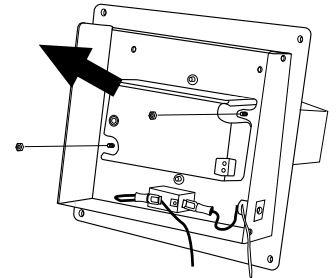

4. Remove the two (2) nuts securing Ballast to the case. Remove the Ballast.

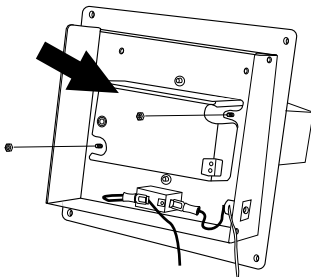

5. Place new Ballast into the original location and secure using the two (2) nuts removed in step 4.

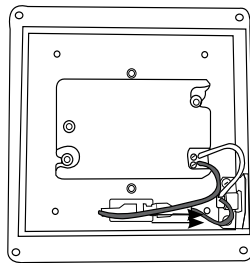

6. To reconnect wiring, insert wire into wire pocket in Ballast until bottomed. Gently pull wire to ensure it is properly connected.



7. Replace Cover and secure with the original four (4) screws.

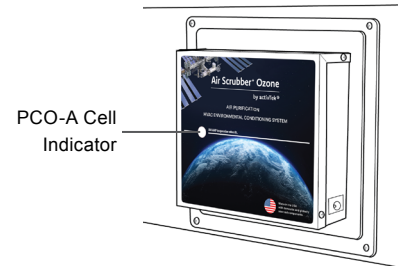

8. Re-install unit if removed from duct. Reconnect Power Cable, turn breaker or fuse power back on and check for proper operation.

NOTE: PCO-A Cell Indicator should be lit when in operation.

For questions on maintenance procedures, please contact your Sales Representative or Customer Service at 866.736.0503 or email support@activTek.net.

Troubleshooting



- **UV Light in operation; disconnect unit from Power Cable before servicing; failure to follow warnings may result in severe eye damage**
- **Live voltage may be present**
- **Disconnect power at the breaker or fuse panel before servicing unit**
- **Always follow OSHA electrical lockout procedures to prevent accidental exposure to electrical energy**



This unit must be installed and serviced by a licensed HVAC contractor or electrician. Failure to do so will void the warranty of the product.

TOOLS REQUIRED:

- 1/4 Nut Driver
 - Phillips Head Screwdriver
 - Multimeter
 - Small Flat Head Screwdriver
 - Flashlight
1. Check the incoming voltage by unplugging the Power Cable from the side of the Air Scrubber+ Ozone by activTek® and placing one probe on the outside of the plug and the other on the inside of the plug. Voltage measurement should read 22–32 VAC. If no voltage is measured, first verify current is getting to the transformer. If it is, then replace the transformer supplying power to the Air Scrubber+ Ozone by activTek.
 2. Leave unit attached to ducting. Remove four (4) Phillips head screws from the Cover of the unit. Remove the Cover. Unplug the black and white wires from the Ballast. Check incoming voltage by placing Multimeter probes on the two exposed wires. Voltage measurement should be between 22–32 VAC. If there is no voltage reading, power is not supplied to the unit. Check power source and verify the Air Scrubber+ Ozone by activTek Safety Switch is fully depressed. Safety Switch plunger is located underneath the unit and is depressed when unit is secured to the Mounting Plate.
 3. Re-plug the black and white wires to the Ballast.
 4. Remove unit from the duct by taking off the four (4) 11/32 thumb nuts that secure the unit to the Mounting Plate.
 5. Remove the two (2) Phillips head screws that hold the PCO-A Cell Assembly in place. Remove the UV Bulb from the 4-pin connector by placing a small flat head screwdriver between the 4-pin connector and the UV Bulb base. Gently pry and lift up on the Cell Assembly until the UV Bulb is unseated from the 4-pin connector, remove the PCO-A Cell Assembly.
 6. Check the continuity of the UV Bulb filaments with a Multimeter by placing the Multimeter probes on the UV Bulb pins that are closest to each other. The Multimeter should beep if the filaments are not broken. Resistance can also be checked if continuity is not available on the Multimeter. Resistance should be between 3–5 ohms. If continuity or resistance check is bad, replace the PCO-A Cell Assembly.
 7. If continuity or resistance check is good, replace the Ballast. To replace the Ballast follow the steps on pages 9-10.

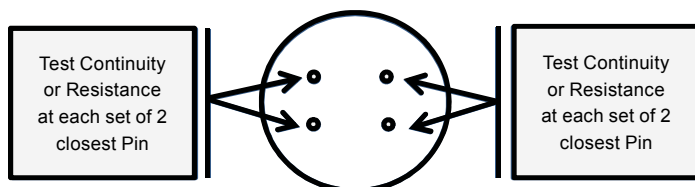
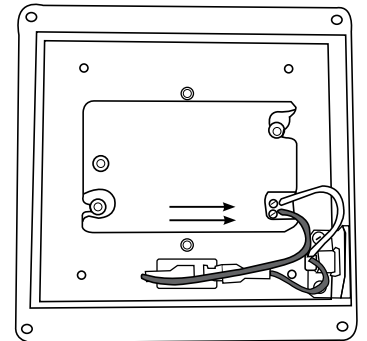

For questions on troubleshooting, please contact your Sales Representative or Customer Service at 866.736.0503 or email support@activTek.net.

Replacement Parts



Use genuine activTek replacement parts only; parts from anyone other than an authorized activTek Representative may damage your unit and void your warranty.

REPLACEMENT PARTS	PART NUMBER
PCO-A Cell Assembly - (1) 9" Cell Assembly (O ₃) NOTE: Not available in California or Canada.	US70678
Ballast	9950102
Power Cable	9950103

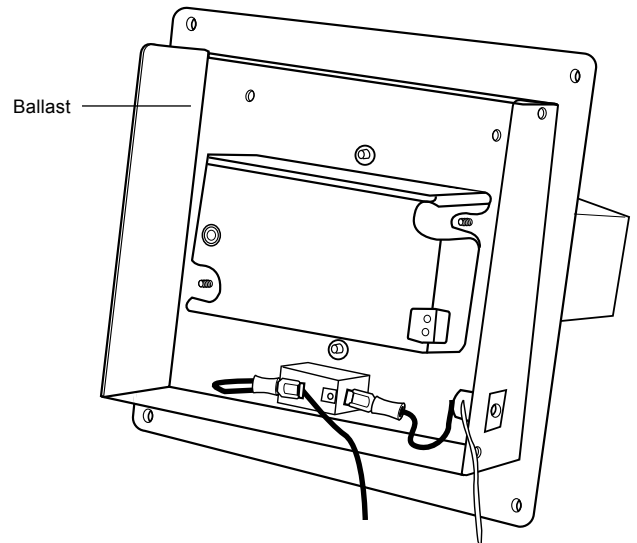
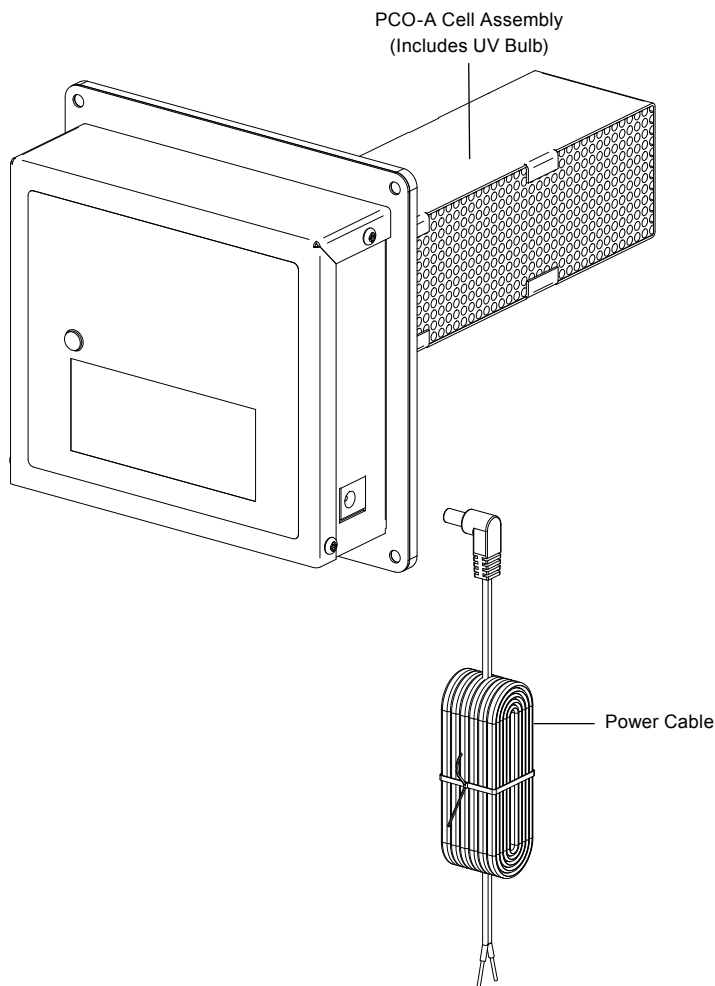

To order replacement parts, please contact your Sales Representative or Customer Service at 866.736.0503 or email support@activTek.net.

Warranty Information

Limited Lifetime Warranty

Lifetime warranty is dependent on registering your Air Scrubber+ Ozone by activTek unit. To register your Air Scrubber+ Ozone by activTek®, please contact Customer Service at 866.736.0503 or email support@activTek.net. Products that are not registered at the time of installation will only be covered by the standard five (5) year limited warranty.

Customer should not repackage and ship the Air Scrubber+ Ozone by activTek® unit due to possibility of irreparable damage. For questions on warranty service, please contact Customer Service at 866.736.0503 or email support@activTek.net.

WHAT IS COVERED BY THIS WARRANTY

We warrant the Air Scrubber+ Ozone by activTek to the customer, subject to the conditions below, against defects in workmanship or material, provided that the products are returned to an authorized activTek location within the following time periods:

- Air Scrubber+ Ozone by activTek (excluding the PCO-A Cell Assembly)
 - Five (5) years for products that are not registered
 - Lifetime for products that are registered and have received Cell Replacement Service on the two (2) year schedule laid out in this owner's manual
- PCO-A Cell Assembly within two (2) years of date of purchase if the Air Scrubber+ Ozone by activTek is connected to a power source where the PCO-A Cell Assembly is "ON" 100% of the time. If the Air Scrubber+ Ozone by activTek is connected to the fan circuit where the PCO-A Cell Assembly cycles "ON and OFF" with the system fan, the PCO-A Cell Assembly is only covered by a ninety (90) day warranty from date of purchase.

INSTALLATION AND MAINTENANCE REQUIREMENTS

This warranty is expressly conditioned upon proper installation, operation, cleaning and maintenance, all in accordance with the Owner's Manual. Failure to meet any of these requirements will void this warranty. Servicing of your Air Scrubber+ Ozone by activTek by parties other than an authorized activTek Representative and/or using parts other than genuine parts will also void this warranty.

This warranty is contingent upon:

- Registration of the product through the approved methods listed above
- Replacing the PCO-A Cell Assembly once every (2) years with a genuine activTek part (proof of change may be required)

HOW TO OBTAIN WARRANTY SERVICE

Customer must register their product by contacting Customer Service at 866.736.0503 or email support@activTek.net and provide proof of purchase (including purchase date) within the above time periods. We will repair or replace and return the product, without charge and within a reasonable period of time, subject to the conditions herein, if its examination shall disclose any part to be defective in workmanship or material. If we, in our discretion, are unable to repair the product after a reasonable number of attempts, we will provide either a refund of the purchase price or a replacement unit, at the company's option. We reserve the right to inspect and/or require confirmation of installation method.

WHAT IS NOT COVERED BY THIS WARRANTY

Ordinary wear and tear shall not be considered a defect in workmanship or material. These warranties do not apply to loss or damage caused by accident, fire, abuse, misuse, improper installation, modification, misapplication, failure to maintain the product as provided herein, or by any repairs other than those provided by an authorized activTek location. This warranty is non-transferable.

UNAUTHORIZED CHANNELS AND MISSING SERIAL NUMBERS

If a valid serial number is missing from the product, the warranty will be voided. activTek products are for sale through authorized Sales Representatives only. Warranties are voided if a product is purchased through unauthorized channels; this includes websites that are not authorized to sell our products OR use activTek trademarked names, images and logos as well as Internet auction sites (e.g. eBay and Craigslist). The only approved internet presence for activTek products is activTek.net. To confirm warranty coverage prior to purchasing a product, please contact Customer Service at 866.736.0503 or email support@activTek.net with the serial number located on the unit.

EXCLUSION OF OTHER WARRANTIES AND CONDITIONS

EXCEPT AS PROVIDED HEREIN, AND TO THE EXTENT CONSISTENT WITH APPLICABLE LAWS, WE MAKE NO REPRESENTATION OR WARRANTY OF ANY KIND. ALL OTHER WARRANTIES OF ANY KIND, EXPRESS OR IMPLIED, ARE HEREBY EXPRESSLY DISCLAIMED, INCLUDING ANY IMPLIED WARRANTY OF MERCHANTABILITY OR FITNESS FOR A PARTICULAR PURPOSE.

LIMITATION OF LIABILITY FOR SPECIAL, INCIDENTAL, OR CONSEQUENTIAL DAMAGES

TO THE EXTENT CONSISTENT WITH APPLICABLE LAWS, WE SHALL NOT IN ANY CASE BE LIABLE FOR SPECIAL, INCIDENTAL OR CONSEQUENTIAL DAMAGES ARISING FROM BREACH OF EXPRESSED OR IMPLIED WARRANTIES, CONDITIONS, GUARANTEES OR REPRESENTATIONS, BREACH OF CONTRACT, NEGLIGENCE OR ANY OTHER LEGAL THEORY. Such excluded damages include, but are not limited to, loss of profits or revenue, and loss of the use of the products, and any loss caused by leaks or other water damage.

FOR U.S. APPLICATION ONLY

This warranty gives you specific legal rights, and you may also have other rights which vary from state to state. Some states do not allow limitations on warranties, or on remedies for breach. In such states, the above limitations may not apply to you.

This warranty is provided by:

activTek Environmental, LLC
1300 Valley Drive
Bristol, VA 24201

SERVICE

Every effort is made to ensure customers receive an up-to-date owner's manual on the use of our products; however, from time to time, modifications to our products may without notice make the information contained herein subject to alteration. For the latest information, please view the owner's manual at activTek.net/manuals.

FCC Declaration & Responsible Party

This equipment has been tested and found to comply with a Class B digital device, pursuant of Part 15 of the FCC Rules. These limits are designed to provide reasonable protection against harmful interference in a residential installation. This equipment generates, uses, and can radiate radio frequency energy, and if not installed and used in accordance with the instructions, may cause harmful interference to radio communications. However, there is no guarantee that interference will not occur in a particular installation. If this equipment does cause harmful interference to radio or television, which can be determined by turning the equipment off and on, the user is encouraged to try to correct the interference by one or more of the following measures:

- Reorient or relocate the receiving antenna.
- Increase the separation between the equipment and receiver.
- Connect the equipment into an outlet on a circuit different from that to which the receiver is connected.
- Consult the Independent HVAC Contractor or an experienced radio/TV technician for help.

FCC DECLARATION OF CONFORMITY

Name: Air Scrubber+ Ozone by activTek

Model: A1013AA

Produced for: activTek Environmental, LLC

This device complies with Part 15 of the FCC Rules.

RESPONSIBLE PARTY

activTek Environmental, LLC

1300 Valley Drive

Bristol, VA 24201

Ph: 866.736.0503

Signature:



Printed Name: Andrew Eide

Title: Chief Technology, Product & Regulatory Officer

Date: 03/17/2026

For information regarding the use of this product, please contact Customer Service at 866.736.0503 or email support@activTek.net

ACTIVTEK.NET

© 2026 activTek Environmental, LLC. All Rights Reserved

